

Mod.
VA

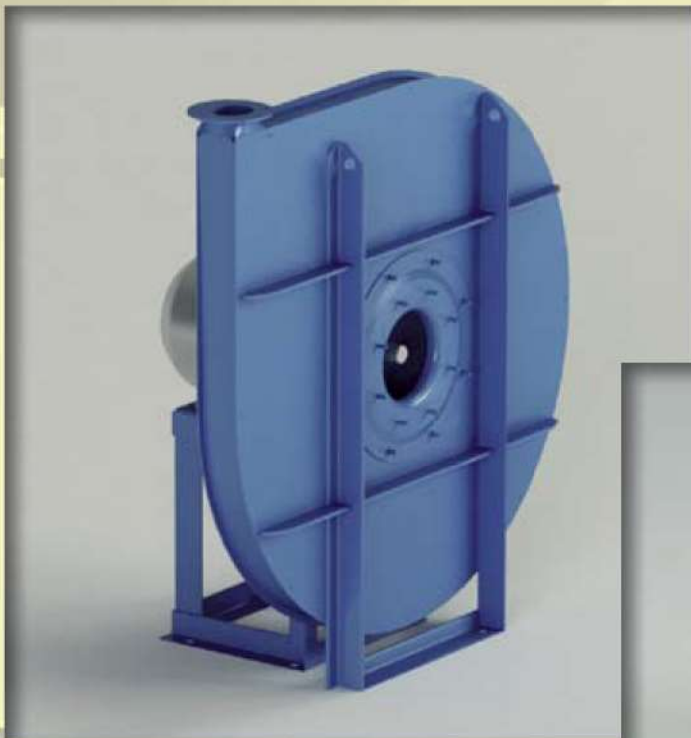

$Q = 50 \div 1500 \text{ m}^3/\text{h}$

$Q = 0.014 \div 0.4 \text{ m}^3/\text{s}$

$p_t = 180 \div 2100 \text{ mmH}_2\text{O}$

$p_t = 1700 \div 20600 \text{ Pa}$



Campo di lavoro

Portate basse. Pressioni alte.

Tipo di pala

Curva, positiva, vedi pag. 2.3.

Applicazioni

Per trasporto pneumatico, polveri, essiccazione, pressurizzazione. Adatto per impieghi nel campo industriale delle fonderie, pastifici, forni, chimico.

Esecuzioni costruttive standard

Es.1-Es.4-Es.5-Es.8-Es.9-Es.12, vedi pag. 2.5-2.6.

Temperature del fluido standard

-10÷+60°C. Per altre temperature vedi da pag. 1.12 a pag. 1.15.

Tipo di costruzione

Ventilatore in lamiera di Fe360, girante in Fe360 equilibrata staticamente e dinamicamente. Per altri materiali vedi pag. da pag. 1.12 a pag. 1.15.

Dati di funzionamento

Condizioni dell'aria all'aspirazione T=20°C, 0m.s.l.m. e ρ=1.2 kg/m³.

Rumorosità

Espressa in potenza sonora L_{WA} [dB(A)] rilevata in campo libero con ventilatore canalizzato, vedi da pag. 1.43 a pag. 1.49.

Orientamenti

N°8 RD (rotazione oraria vista lato trasmissione) e N°8 LG. Ventilatore in versione imbullonata. Vedi pag. 2.7.

Costruzioni speciali

Vedi da pag. 2.20 a pag. 2.34.

Avviamento ventilatore

I ventilatori serie VA devono necessariamente essere avviati con aspirazione completamente chiusa.

Verificare con i dati del costruttore del motore elettrico l'effettivo numero di avviamenti/ora che è in grado di sopportare il motore; salvo diverse indicazioni considerare un massimo di un avviamento/ora.

In caso sia prevista la necessità di avviare il ventilatore più frequentemente è possibile avviare installando un motore di taglia superiore.

In avviamento la corrente di spunto può arrivare fino a 7 volte la corrente nominale, dimensionare in maniera opportuna la componentistica elettrica.

Classi giranti

La seguente tabella fa riferimento a condizioni di lavoro standard. In condizioni di esercizio gravose si consiglia di contattare il servizio clienti di MZ Aspiratori per conoscere la tipologia di girante più idonea.

■ **Domaine de travail**

Faibles débits. Hautes pressions.

Type d'ailette

Courbée, positive, voir page 2.3.

Applications

Pour transport pneumatique, poussières, séchage, pressurisation. Convient à l'emploi dans le domaine industriel des fonderies, fabriques de pâtes, fours, chimique.

Configurations de constructions standard

Ex.1 - Ex.4 - Ex.5 - Ex.8 - Ex.9 - Ex.12, voir pages 2.5-2.6.

Températures du fluide standard

-10 ÷ +60°C. Pour d'autres températures voir pages 1.12 - 1.15.

Type de fabrication

Ventilateur en tôle de Fe360, turbine en Fe360 équilibrée statiquement et dynamiquement. Pour d'autres matériaux, voir pages 1.12 - 1.15.

Données de fonctionnement

Conditions de l'air à l'aspiration T=20°C, 0 m asl et ρ=1.2 kg/m³.

Niveau sonore

Exprimé en puissance sonore L_{WA} [dB(A)], relevé à l'air libre avec un ventilateur canalisé, voir pages 1.43 - 1.49.

Orientations

8 RD (rotation dans le sens des aiguilles d'une montre côté transmission) et 8 LG. Ventilateur en version boulonnée. Voir page 2.7.

Fabrications spéciales

Voir pages 2.20 - 2.34.

Mise en marche du ventilateur

Les ventilateurs série VA doivent nécessairement être mis en marche avec une aspiration totalement fermée. Vérifier le nombre réel de mises en marche/heure avec les données du constructeur du moteur électrique, que le moteur est en mesure de supporter. Sauf indications contraires, considérer un maximum de mise en marche/heure. S'il est prévu que le ventilateur doit être mis en marche plus fréquemment, on peut remédier en installant un moteur de dimension supérieure. A la mise en marche, le courant de démarrage peut arriver à 7 fois le courant nominal, prévoir une installation électrique de dimension adaptée à cet effet.

Classes de turbines

Le tableau ci-dessus fait référence aux conditions de travail normales, en conditions de travail pénibles, on préconise de contacter le service clientèle de MZ Aspiratori pour connaître le type de turbine le plus adapté.

GRANDEZZA VENTILATORE • Grandeur • Size • Größe • Tamaño	RPM MASSIMO • Maxi tours/min. • Max rpm • Max. U/min R.p.m. máx.		
	CLASSE I	CLASSE II	CLASSE III
VA310	5000		
VA350	5000		
VA400	5000		
VA450/R	5000		
VA450	5000		
VA500	5000		
VA560/R	5000		
VA560	4700	5000	
VA630/R	4400	4850	
VA630	4100	4550	5000
VA710/R	3700	4100	4500
VA710	3550	3850	4250
VA800/R	3400	3700	4000
VA800	3250	3550	3850
VA900/R	3100	3400	3700
VA900	2960	3250	3550
VA1000/R	3100	3550	3850
VA1000	3300	3550	3900

VALORI VALIDI FINO A 60°C

• Valeurs valables jusqu'à 60°C • Values valid up to 60°C
• Werte bis 60°C gültig • Valores válidos hasta 60°C

FRA • entre • between • zwischen • entre	60°C	E • et • and • und • y	100°C	DECLASSARE VELOCITÀ • déclasser vitesse • degrade speed • Geschwindigkeit herabsetzen • rebajar velocidad	4%
	100°C		150°C		10%
	150°C		200°C		16%
	200°C		250°C		23%
	250°C		300°C		30%
	300°C		350°C		37%
	350°C		400°C		45%
	400°C		450°C		54%
	450°C		500°C		64%

■ **Field of operation**

Low flow rates. High pressures.

Blade type

Curve, positive, see pg. 2.3.

Applications

For pneumatic transport, dust, drying, pressurization. Suitable for applications in industrial fields like foundries, pasta factories, bakeries, chemicals.

Standard constructional arrangements

Arr.1 - Arr.4 - Arr.5 - Arr.8 - Arr.9 - Arr.12, see pgs. 2.5-2.6.

Standard fluid temperatures

-10÷+60°C. For other temperatures see pgs. 1.12 to 1.15.

Type of construction

Fan in Fe360 plate, impeller in Fe360 statically and dynamically balanced. For other materials see pgs. 1.12 to 1.15.

Operating specifications

Condition of inlet air T=20°C, 0 m above sea level and ρ=1.2 kg/m³.

Noise level

Expressed as sound power L_{WA} [dB(A)] measured in free field with ducted fan, see pgs. 1.43 to 1.49.

Orientations

No.8 RD (clockwise viewed from transmission side) and No.8 LG. Fan in bolted version. See pg. 2.7.

Special applications

See pgs. 2.20 to 2.34.

Fan start-up

The VA series fans must be started-up with inlet completely closed.

Check the electrical motor manufacturer's data for the effective number of start-ups per hour that the motor is able to sustain; unless otherwise indicated take one start-up per hour to be the maximum.

If it is necessary to start up the fan more frequently and this can be achieved by installing a larger motor.

During start-up the peak current can reach as much as 7 times the nominal current and the electrical components should be scaled appropriately.

Impeller classes

The above table refers to standard operating conditions, in heavy-duty service conditions it is advisable to contact the MZ Aspiratori Customer Service to establish the most suitable type of impeller.

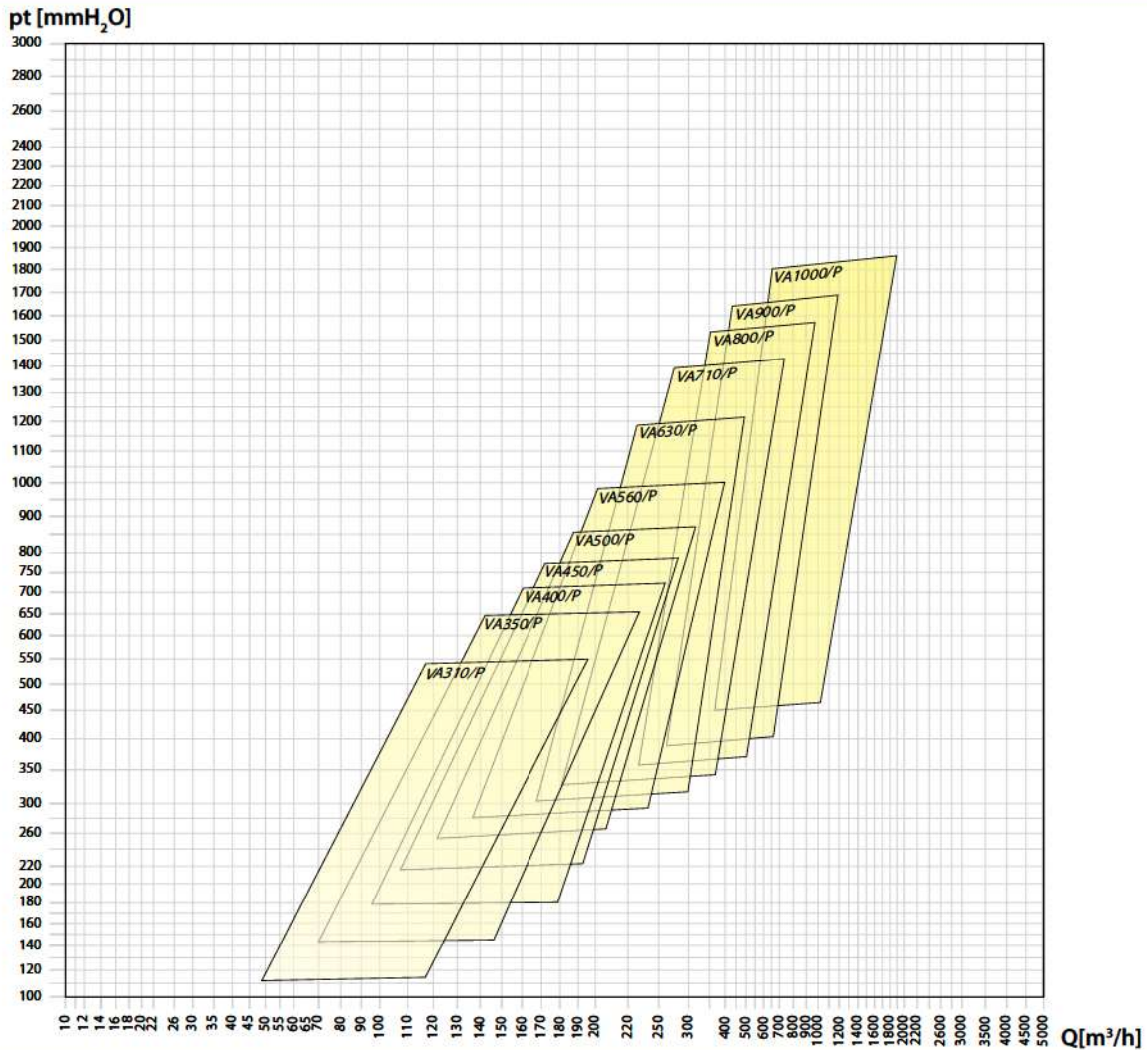

Arbeitsbereich

Niedrige Fördermengen. Hohe Drücke.

Schaufelform

positive Kurve, siehe Seite 2.3.

Anwendungen

Zum Transport von Stäuben, zur Trocknung und für mit Überdruck zu beaufschlagende Räume. Zur Verwendung im industriellen Bereich, Giessereien, Nudelfabriken, Öfen und der Chemie geeignet.

Konstruktive Standardausführungen

Ausf. 1-Ausf. 4-Ausf. 5-Ausf. 8-Ausf. 9-Ausf. 12, siehe Seiten 2.5-2.6..

Standardtemperatur des Mediums

-10 ÷ +60°C. Für andere Temperaturen siehe Seiten 1.12 bis 1.15.

Konstruktionsart

Ventilator aus Blech Fe360, Laufrad aus Fe360, statisch und dynamisch ausgewuchtet. Für andere Materialien siehe Seiten 1.12 bis 1.15.

Betriebsdaten

Physikalischer Zustand der Ansaugluft T=20°C, 0 m ü. M. und ρ=1.2 kg/m³.

Geräuschpegel

Angegeben als Schalleistungspegel L_{WA} [dB(A)] mit Messung im Freifeld und an Rohren angeschlossenem Ventilatore, siehe Seiten 1.43 bis 1.49.

Ausrichtung

8 Modelle RD (Drehrichtung im Uhrzeigersinn, von Antriebsseite aus gesehen) und 8 Modelle LG. Angeschraubter Ventilator, siehe Seite 2.7.

Spezialausführungen

Siehe Seiten 2.20 bis 2.34.

Ventilator-Anlauf

Für die Ventilatoren der Reihe VA muss unbedingt ein Anlauf mit vollständig geschlossener Ansaugseite sichergestellt sein. Mit den Angaben des Herstellers des Elektromotors die Anzahl der zulässigen Anläufe pro Stunde überprüfen; falls nicht anders angegeben, ist von einem Anlauf pro Stunde auszugehen. Falls häufigere Anläufe vorzusehen sind, kann ein stärkerer Elektromotor eingebaut werden. Während des Anlaufs kann der Anlaufstrom bis zum Siebenfachen des Nennstroms betragen, der elektrische Anschluss ist in geeigneter Weise anzulegen.

Laufradklassen

Die obestehende Tabelle bezieht sich auf normale Betriebsbedingungen. Bei erschwerenden Betriebsbedingungen wird empfohlen, den Kundenservice der MZ Aspiratori zu kontaktieren, um den am besten geeigneten Laufradtyp zu bestimmen.

Campo de trabajo

Caudales bajos. Presiones altas.

Tipo de pala

Curva, positiva, ver pág. 2.3.

Aplicaciones

Para transporte neumático, polvos, desecación y presurización. Apto para el uso en el campo industrial: fundiciones, fábricas de pasta, hornos e industria química.

Variantes constructivas estándares

Ejec.1-Ejec.4-Ejec.5-Ejec.8-Ejec.9-Ejec.12, ver págs. 2.5-2.6..

Temperaturas del fluido estándares

De -10 a +60°C. Para otras temperaturas, ver págs. de 1.12 a 1.15.

Tipo de construcción

Ventilador de chapa en Fe360, rotor en Fe360 equilibrado estática y dinámicamente. Para otros materiales, ver págs. de 1.12 a 1.15.

Datos de funcionamiento

Condiciones del aire en aspiración T=20°C, 0 m SNM y ρ=1.2 kg/m³.

Niveles de ruido

Expresados en potencia sonora L_{WA} [dB(A)] medida en campo abierto con ventilador canalizado, ver págs. de 1.43 a 1.49.

Orientaciones

8 RD (rotación dextrógrá vista desde el lado de transmisión) y 8 LG. Ventilador en versión empernada. Ver pág. 2.7.

Construcciones especiales

Ver págs. de 2.20 a 2.34.

Puesta en marcha del ventilador

Los ventiladores de la serie VA deben necesariamente encenderse con la aspiración completamente cerrada. Comprobar a partir de los datos del fabricante del motor eléctrico el número efectivo de encendidos/hora que el motor puede soportar. Considerar un máximo de un encendido/hora, de no indicarse lo contrario. En caso de que se plantee la necesidad de encender el ventilador con mayor frecuencia, la instalación de un motor de mayor tamaño puede evitar el problema. Durante el encendido, la corriente de arranque puede llegar a ser 7 veces la corriente nominal, por lo tanto, el tamaño y la capacidad de los componentes eléctricos deberán calcularse de acuerdo con ello.

Clases de rotores

La tabla arriba hace referencia a condiciones de trabajo estándares, en condiciones de funcionamiento pesadas, se aconseja llamar al Servicio de atención al cliente de MZ Aspiratori para conocer el tipo de rotor más adecuado.

Tipo • Type • Type • Typ • Tipo		P inst. [kW]	n	LpA [dB(A)]	Tolleranza sulla portata ±5% • Tolérance sur le débit ±5% • Load tolerance ±5% • Durchsatztoleranz ±5% • Tolerancia respecto caudal ±5%									
Ventilatore • Ventilateur • Fan • Ventilator • Ventilador	Motore • Moteur • Motor • Motor • Motor				Q [m³/h]									
					50	55	60	70	90	110	145	180	215	250
					pt[mmH ₂ O]									
VA310/P2	63	0,25	2830	54	178	179	180	181	182	177				
VA350/P2	71	0,37	2830	58			226	228	230	231	227	224		
VA400/P2	71	0,55	2830	61					295	296	298	299	297	294
VA450/P2	80	0,75	2850	63						377	379	381	382	383
VA500/P2	80	1,1	2870	64							443	454	464	470
VA560/P2	90	1,5	2900	69								595	612	625
VA630/P2R	90	1,5	2900	70								650	671	686
VA630/P2	90	2,2	2920	71								714	744	775
VA710/P2R	100	3	2920	73									808	841
VA710/P2	112	4	2930	74									897	912
VA800/P2R	112	4	2930	74										
VA800/P2R	132	5,5	2940	76										
VA800/P2	132	5,5	2940	76										
VA800/P2	132	7,5	2940	78										
VA900/P2R	132	7,5	2940	78										
VA900/P2R	160	11	2950	79										
VA900/P2	160	11	2950	80										
VA900/P2	160	15	2960	81										
VA1000/P2R	160	18,5	2960	82										
VA1000/P2	180	22	2970	83										

Il livello di pressione sonora ponderato A, LpA (cap.14), corrisponde al valore rilevato, nelle condizioni di prova, nel punto di massima rumorosità.

Tolleranza sulla rumorosità ±4dB(A)
 • Tolérance sur le bruit ±4dB(A) • Noise tolerance ±4dB(A)
 • Geräushtoleranz ±4dB(A) • Tolerancia respecto a ruido ±4dB(A)

Q [m³/h]															
290	325	360	400	430	470	540	650	720	790	865	935	1080	1225	1440	1638
pt[mmH ₂ O]															
382															
477	473														
634	630	628													
696	701														
795	805	807	807												
866	882	897	907	914	917										
943	968	990	1009	1020	1028	1037									
1020	1045	1068	1090	1105	1120										
1027	1053	1076	1098	1113	1128	1149	1163	1165							
	1142	1182	1203	1223	1238	1264									
	1142	1182	1203	1223	1238	1264	1300	1325							
			1305	1330	1348	1390	1435								
			1315	1340	1358	1400	1445	1467	1485	1495	1504				
				1427	1475	1520	1570	1600	1620	1646					
					1485	1530	1580	1610	1630	1656	1678	1694	1707		
						1638	1690	1740	1774	1795	1830	1863	1890	1896	
							1835	1875	1927	1958	1998	2040	2090	2110	2115

■ Le niveau de pression sonore pondérée A, LpA (chap. 14), correspond à la valeur relevée dans les conditions d'essai au point de niveau sonore maximum.

■ The A-weighted sound power level, LpA (Chap.14), is the value measured in test conditions at the point of maximum noise level.

■ Der nach A bewertete Schalldruckpegel LpA (Kap. 14) entspricht in den Testbedingungen dem höchsten gemessenen Wert des Geräuschpegels.

■ El nivel de presión sonora ponderado A, LpA (cap. 14), corresponde al valor medido, en las condiciones de prueba, en el punto con máximos niveles de ruido.

VA

Tipo • Type • Type • Typ • Tipo		P inst. [kW]	n	LpA [dB(A)]	Tolleranza sulla portata ±5% • Tolérance sur le débit ±5% • Load tolerance ±5% • Durchsatztoleranz ±5% • Tolerancia respecto caudal ±5%									
Ventilatore • Ventilateur • Fan • Ventilator • Ventilador	Motore • Moteur • Motor • Motor • Motor				Q [m³/h]									
					50	55	60	70	90	110	145	180	215	250
					pt[mmH ₂ O]									
VA310/P2	63	0,25	2830	54	173	173	174	174	172	163				
VA350/P2	71	0,37	2830	58			218	219	218	215	204	191		
VA400/P2	71	0,55	2830	61					280	277	272	263	249	232
VA450/P2	80	0,75	2850	63						354	348	340	329	317
VA500/P2	80	1,1	2870	64							407	408	406	398
VA560/P2	90	1,5	2900	68								536	541	539
VA630/P2R	90	1,5	2900	69								586	593	594
VA630/P2	90	2,2	2920	70								642	658	672
VA710/P2R	100	3	2920	72									733	756
VA710/P2	112	4	2930	73									810	817
VA800/P2R	112	4	2930	73										
VA800/P2R	132	5,5	2940	74										
VA800/P2	132	5,5	2940	75										
VA800/P2	132	7,5	2940	76										
VA900/P2R	132	7,5	2940	76										
VA900/P2R	160	11	2950	77										
VA900/P2	160	11	2950	79										
VA900/P2	160	15	2960	79										
VA1000/P2R	160	18,5	2960	80										
VA1000/P2	180	22	2970	81										

Il livello di pressione sonora ponderato A, LpA (cap.14), corrisponde al valore rilevato, nelle condizioni di prova, nel punto di massima rumorosità.

Tolleranza sulla rumorosità ±4dB(A)															
• Tolérance sur le bruit ±4dB(A) • Noise tolerance ±4dB(A)															
• Geräushtoleranz ±4dB(A) • Tolerancia respecto a ruido ±4dB(A)															
Q [m³/h]															
290	325	360	400	430	470	540	650	720	790	865	935	1080	1225	1440	1638
pt[mmH ₂ O]															
297															
386	364														
530	509	487													
585	572														
673	664	647	623												
770	777	781	779	777	767										
836	850	860	866	867	861	845									
900	914	925	933	938	938										
906	921	932	940	944	945	939	907	877							
	994	1019	1026	1034	1035	1033									
	994	1019	1026	1034	1035	1033	1020	1009							
			1139	1156	1165	1190	1209								
			1147	1163	1173	1197	1217	1222	1223	1216	1208				
				1231	1264	1290	1313	1324	1327	1332					
					1272	1298	1321	1332	1335	1340	1341	1319	1289		
						1379	1403	1428	1441	1442	1453	1443	1424	1360	
							1510	1528	1553	1561	1576	1573	1570	1519	1452

■ Le niveau de pression sonore pondérée A, LpA (chap. 14), correspond à la valeur relevée dans les conditions d'essai au point de niveau sonore maximum.

■ Der nach A bewertete Schalldruckpegel LpA (Kap. 14) entspricht in den Testbedingungen dem höchsten gemessenen Wert des Geräuschpegels.

■ The A-weighted sound power level, LpA (Chap.14), is the value measured in test conditions at the point of maximum noise level.

■ El nivel de presión sonora ponderado A, LpA (cap. 14), corresponde al valor medido, en las condiciones de prueba, en el punto con máximos niveles de ruido.

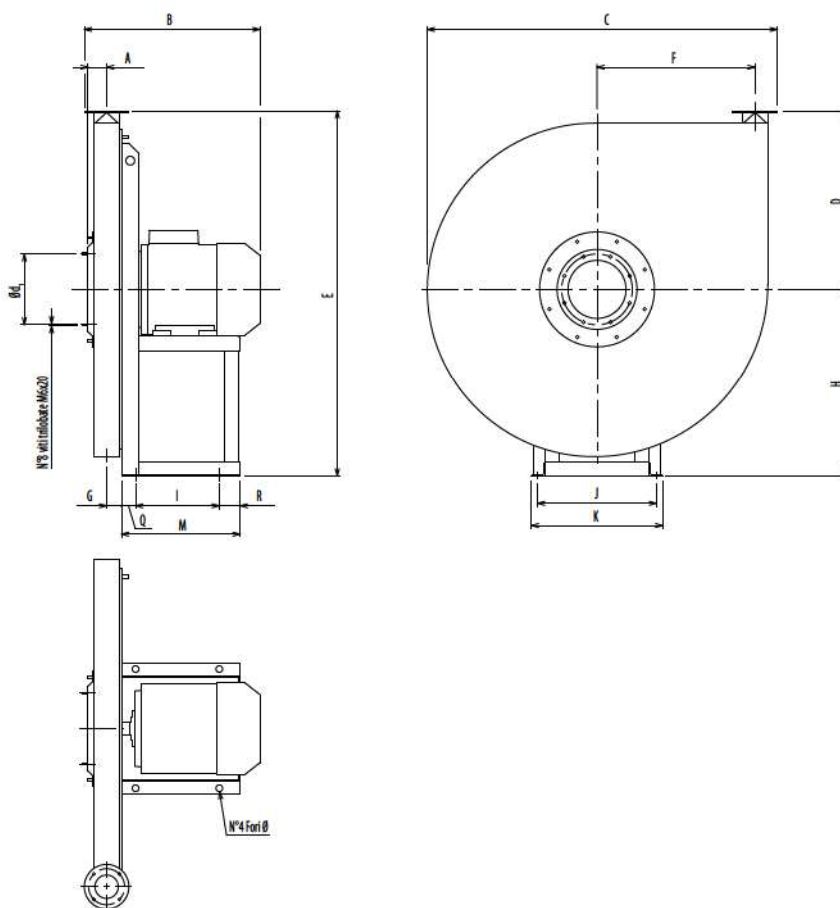

TIPO - Type		PESO Weight Kg	PD ¹ Kgf x m ²	VENTILATORE Fan								FLANGIA ASPIRANTE Inlet flange				
VENTILATORE Fan	MOTORE Motor			A	B	C	D	E	F	G	H	d	d ₁	d ₂	n°	Ø
VA310/P2	63 B2	29	0.14	34	280	512	270	550	220	30	280	145	182	215	8	8
VA350/P2	71 A2	33	0.20	34	310	512	270	550	220	30	280	145	182	215	8	8
VA400/P2	71 B2	44	0.36	34	310	670	350	705	300	31	355	145	182	215	8	8
VA450/P2	80 A2	46	0.52	34	335	670	350	705	300	31	355	145	182	215	8	8
VA500/P2	80 B2	51	0.72	34	335	670	350	705	300	31	355	145	182	215	8	8
VA560/P2	90 S2	89	1	34	380	782	405	830	355	32	425	145	182	215	8	8
VA630/P2R	90 S2	116	1.8	34	380	782	405	830	355	32	425	145	182	215	8	8
VA630/P2	90 L2	119	2	34	380	782	405	830	355	32	425	145	182	215	8	8
VA710/P2R	100 L2	149	2.7	40	440	888	455	930	400	38	475	165	200	235	8	8
VA710/P2	112 M2	168	3.4	40	460	888	455	930	400	38	475	165	200	235	8	8
VA800/P2R	112 M2	185	4	40	460	990	505	1035	450	38	530	165	200	235	8	8
VA800/P2R	132 SA2	195	4	40	500	990	505	1035	450	38	530	165	200	235	8	8
VA800/P2	132 SA2	197	5.4	40	500	990	505	1035	450	38	530	165	200	235	8	8
VA800/P2	132 SB2	197	5.4	40	500	990	505	1035	450	38	530	165	200	235	8	8
VA900/P2R	132 SB2	330	9	49	505	1127	570	1170	500	48	600	185	219	250	8	8
VA900/P2R	160 MA2	390	9	49	610	1127	570	1170	500	48	600	185	219	250	8	8
VA900/P2	160 MA2	390	11	49	610	1127	570	1170	500	48	600	185	219	250	8	8
VA900/P2	160 MB2	390	11	49	610	1127	570	1170	500	48	600	185	219	250	8	8
VA1000/P2R	160 L2	442	13	49	610	1248	635	1305	560	48	670	185	219	250	8	8
VA1000/P2	180 M2	501	15	49	691	1248	635	1305	560	48	670	185	219	250	8	8

DIMENSIONI D'INGOMBRO E PESI

■ DIMENSIONS D'ENCOMBREMENT ET POIDS ■ OVERALL DIMENSIONS AND WEIGHT ■ AUSMAßE UND GEWICHTE ■ DIMENSIONES QUE OCUPA Y PESOS



Ulteriori informazioni e quote:
 ■ Ulérieures informations et cotes:
 ■ Further information and sizes:
 ■ Weitere Infos und Größen:
 ■ Más informaciones y medidas:

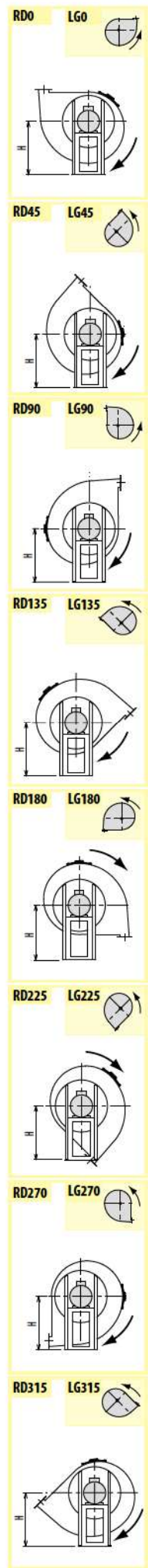
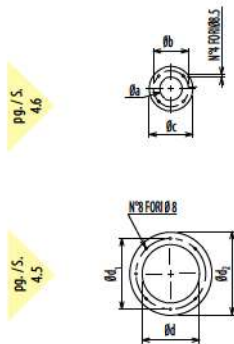

FLANGIA PREMENTE Outlet flange					BASAMENTO Base						
a	b	c	N°	Ø	I	J	K	M	Q	R	Ø
54	84	104	4	8.5	86	184	206	145	45	14	10
54	84	104	4	8.5	121	203	225	189	45	23	10
54	84	104	4	8.5	121	203	225	189	45	23	10
54	84	104	4	8.5	121	203	225	211	45	45	10
54	84	104	4	8.5	121	203	225	211	45	45	10
54	84	104	4	8.5	133	234	260	246	55	58	10
54	84	104	4	8.5	133	234	260	246	55	58	10
54	84	104	4	8.5	133	234	260	246	55	58	10
66	102	126	4	8.5	197	289	324	276	30	49	12
66	102	126	4	8.5	197	289	324	276	30	49	12
66	102	126	4	8.5	197	289	324	276	30	49	12
66	102	126	4	8.5	237	337	372	336	40	59	12
66	102	126	4	8.5	237	337	372	336	40	59	12
66	102	126	4	8.5	237	337	372	336	40	59	12
83	118	143	4	8.5	237	337	372	336	40	59	12
83	118	143	4	8.5	337	395	440	436	50	49	14
83	118	143	4	8.5	337	395	440	436	50	49	14
83	118	143	4	8.5	337	395	440	436	50	49	14
83	118	143	4	8.5	337	395	440	436	50	49	14
83	118	143	4	8.5	357	434	488	460	70	33	17



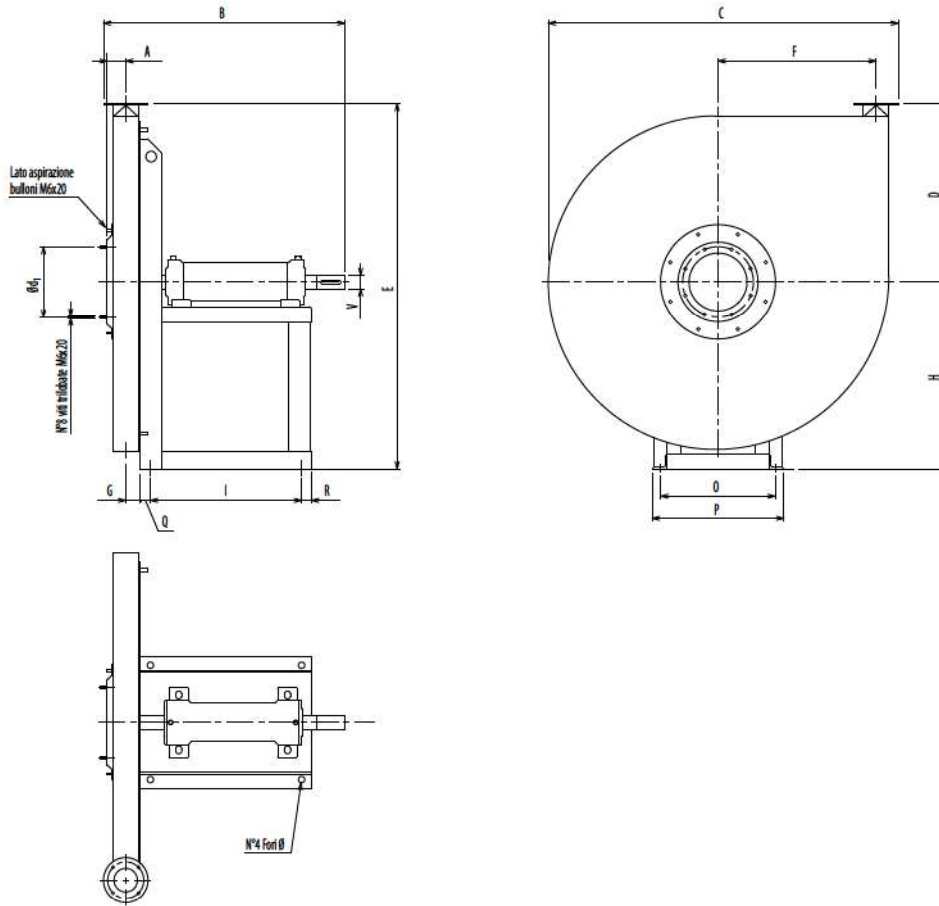

VENTILATORE Fan	PESO Weight Kg	PD ² Kgf x m ²	ALBERO Shaft V	VENTILATORE Fan										FLANGIA ASPIRANTE Inlet flange				
				A	B	C	D	E	F	G	H	Q	Ø	d	d ₁	d ₂	n°	Ø
VA350/T	28	0.20	19	34	400	512	270	550	220	30	280	55	10	145	182	215	8	8
VA400/T	35	0.36	19	34	405	670	350	705	300	31	355	55	12	145	182	215	8	8
VA450/T	38	0.52	19	34	405	670	350	705	300	31	355	55	12	145	182	215	8	8
VA500/T	42	0.72	19	34	405	670	350	705	300	31	355	55	14	145	182	215	8	8
VA560/T	65	1	24	34	485	782	405	830	355	32	425	40	14	145	182	215	8	8
VA630/T	70	2	24	34	485	782	405	830	355	32	425	40	14	145	182	215	8	8
VA710/T	100	3.4	28	40	650	888	455	930	400	38	475	50	14	165	200	235	8	8
VA800/T	125	5.4	28	40	650	990	505	1035	450	38	530	50	14	165	200	235	8	8
VA900/T	220	11	38	49	695	1127	570	1170	500	48	600	50	14	185	219	250	8	8
VA1000/T	330	18	42	49	850	1248	635	1305	560	50	670	50	14	185	219	250	8	8

DIMENSIONI D'INGOMBRO E PESI

■ DIMENSIONS D'ENCOMBREMENT ET POIDS ■ OVERALL DIMENSIONS AND WEIGHT ■ AUSMAßE UND GEWICHTE ■ DIMENSIONES QUE OCUPA Y PESOS

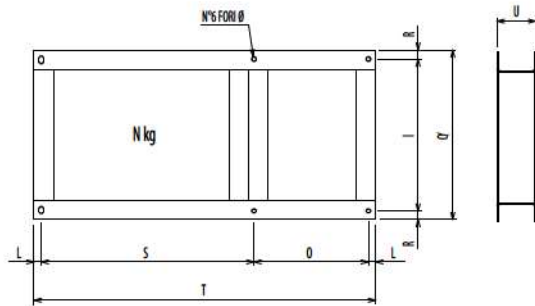

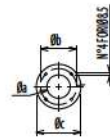

pg. / S.
4,6



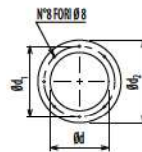

Ulteriori informazioni e quote:
■ Ulérieures informations et cotes:
■ Further information and sizes:
■ Weitere Infos und Größen:
■ Más informaciones y medidas:

pg. / S.
4,5





RD0 LG0 

RD45 LG45 

RD90 LG90 

RD135 LG135 

RD180 LG180 

RD225 LG225 

RD270 LG270 

RD315 LG315 

FLANGIA PREMENTE Outlet flange			BASAMENTO Base										
a	b	c	I	L	N	O	P	Q'	R	S	T	U	Ø
54	84	104	210	13.5	8	228	255	244	17	445	700	80	12
54	84	104	210	13.5	8	228	255	244	17	445	700	80	12
54	84	104	210	13.5	8	228	255	244	17	445	700	80	12
54	84	104	210	13.5	8	228	255	244	17	445	700	80	12
54	84	104	284	18	20	288	324	330	23	576	900	100	15
54	84	104	284	18	20	288	324	330	23	576	900	100	15
66	102	126	407	22.5	25	355	400	463	28	660	1060	120	15
66	102	126	407	22.5	25	355	400	463	28	660	1060	120	15
83	118	143	407	22.5	30	355	400	463	28	780	1180	120	15
83	118	143	477	22.5	45	485	530	543	33	780	1310	120	15

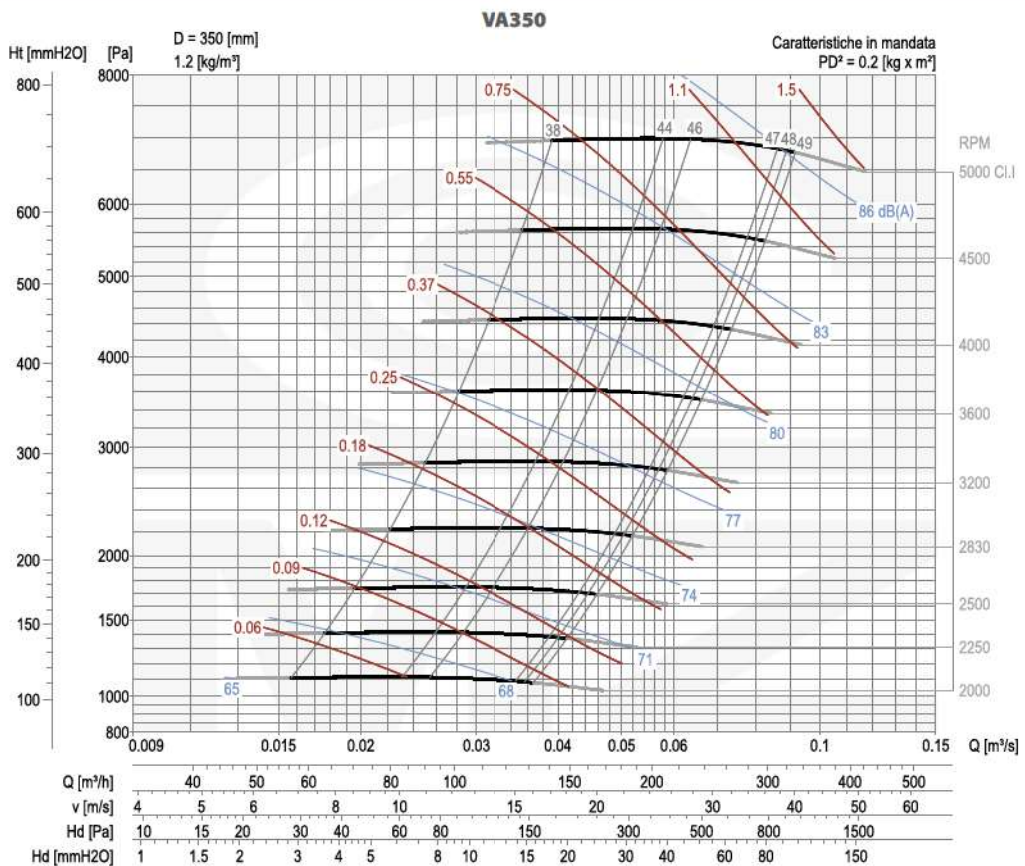
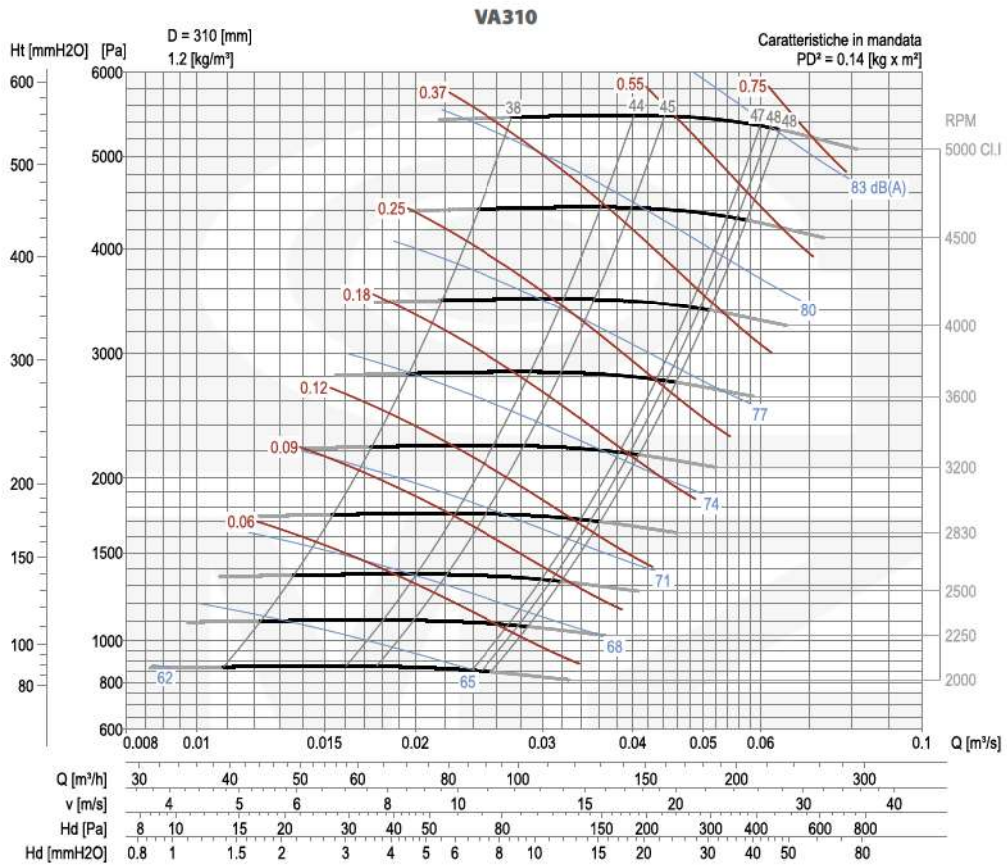

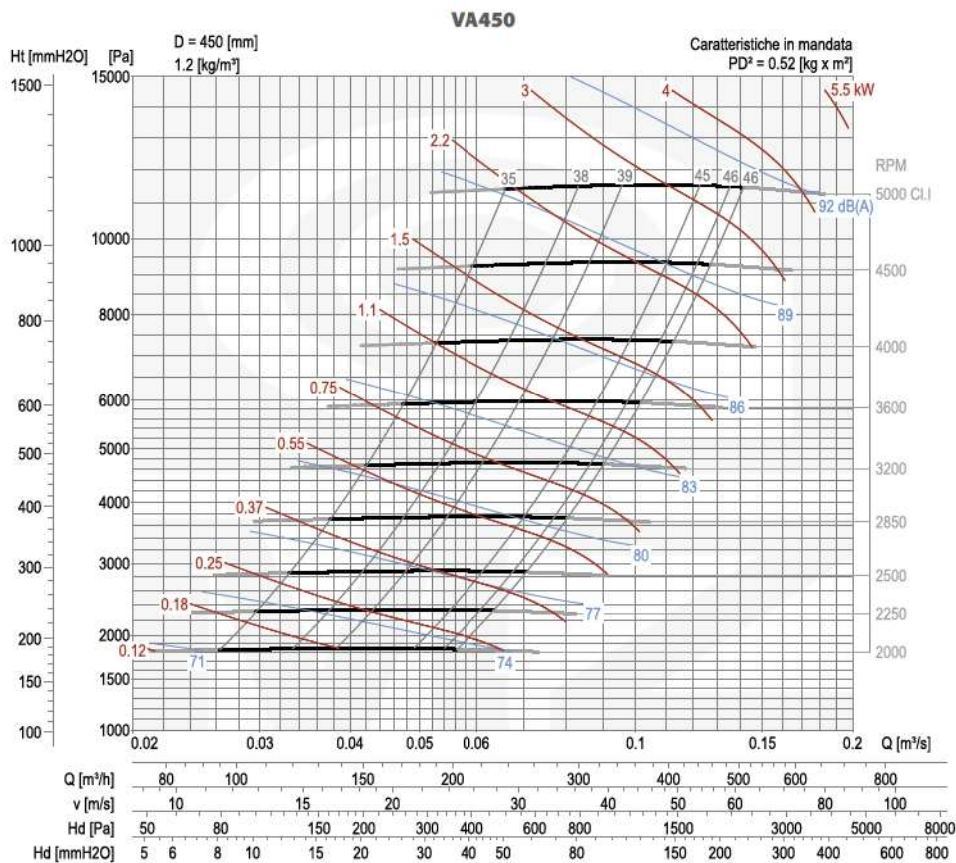
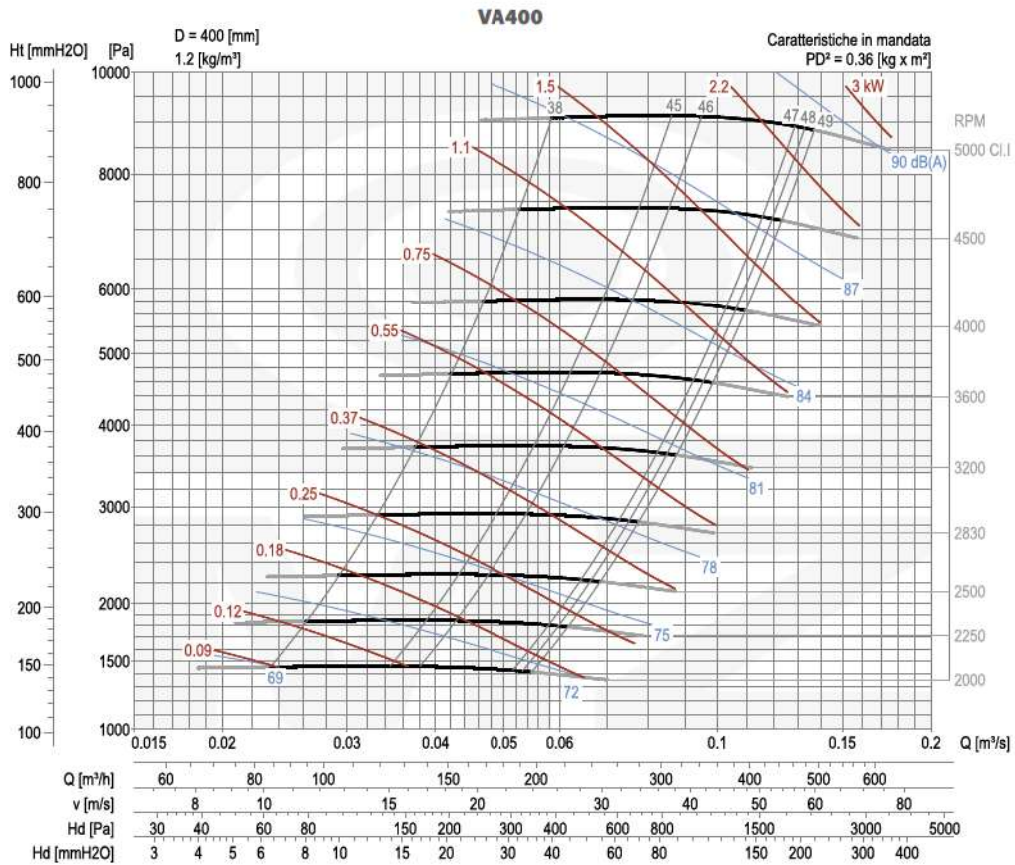

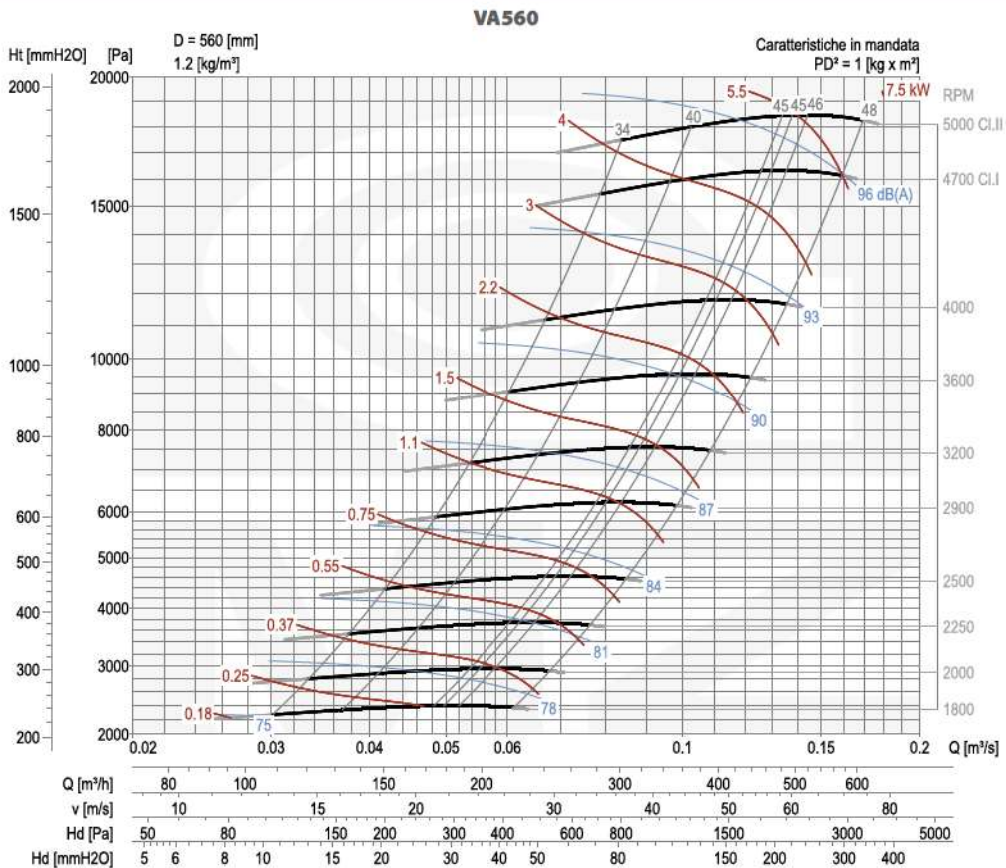
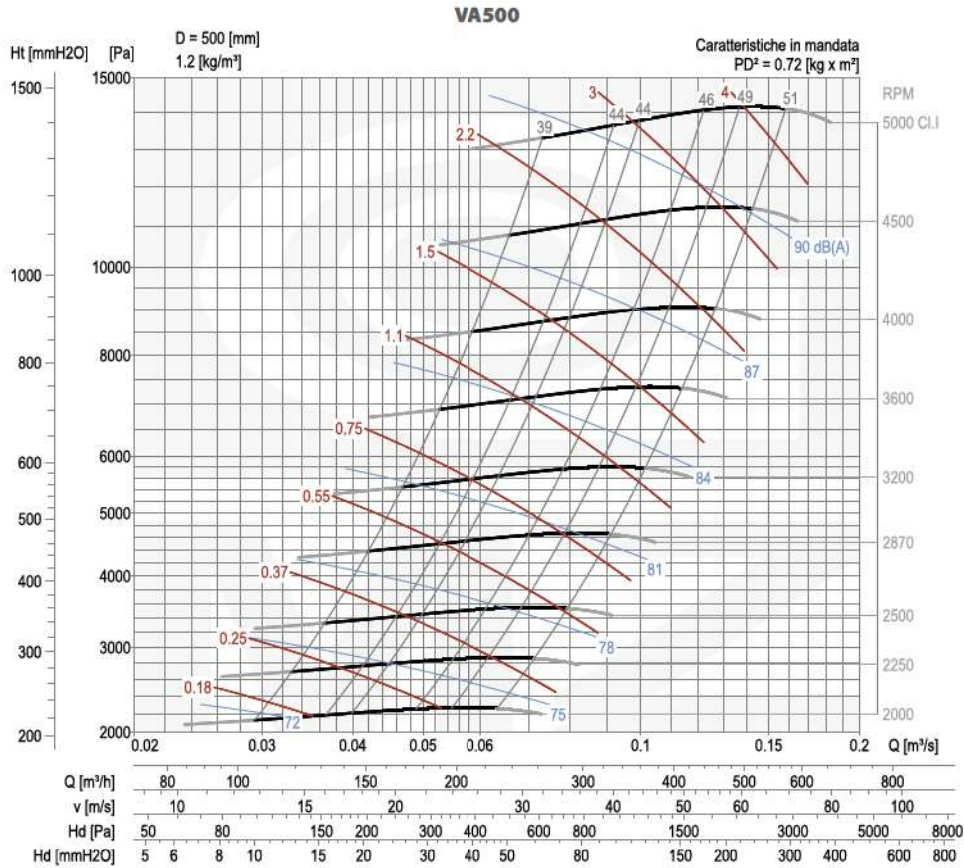

CURVE DI FUNZIONAMENTO

■ COURBES DE FONCTIONNEMENT ■ WORKING CURVES ■ FUNKTIONSKURVEN ■ CURVAS DE FUNCIONAMIENTO

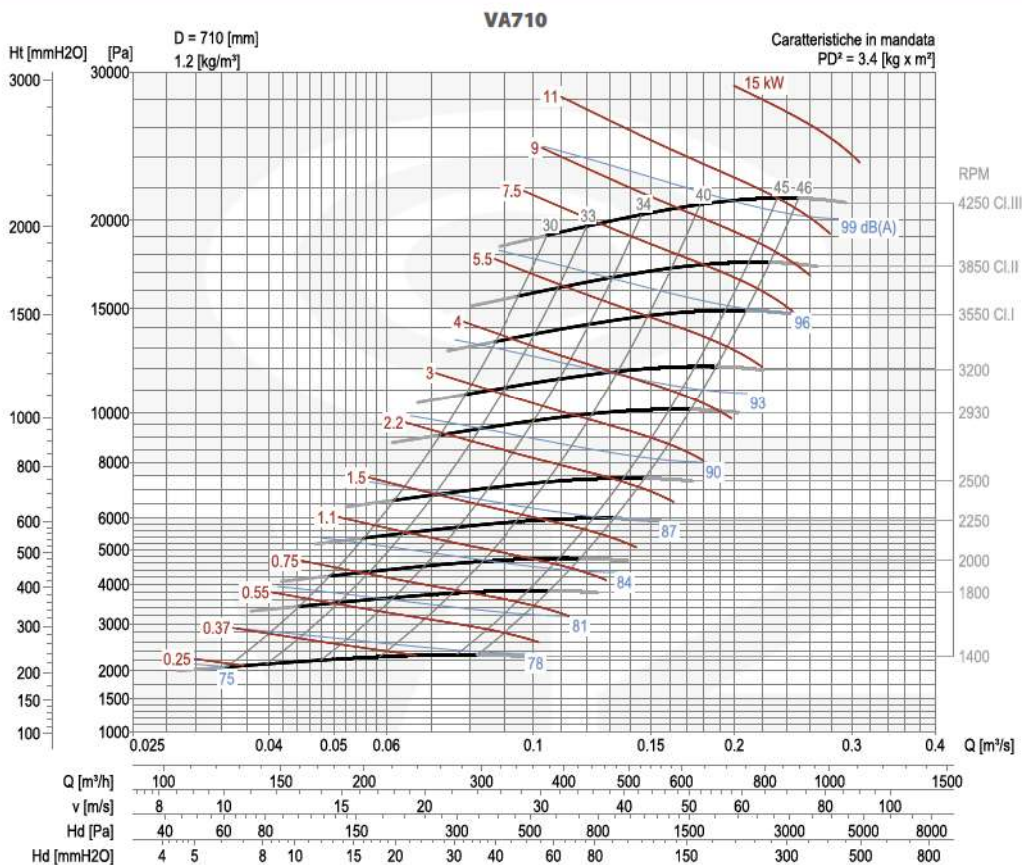
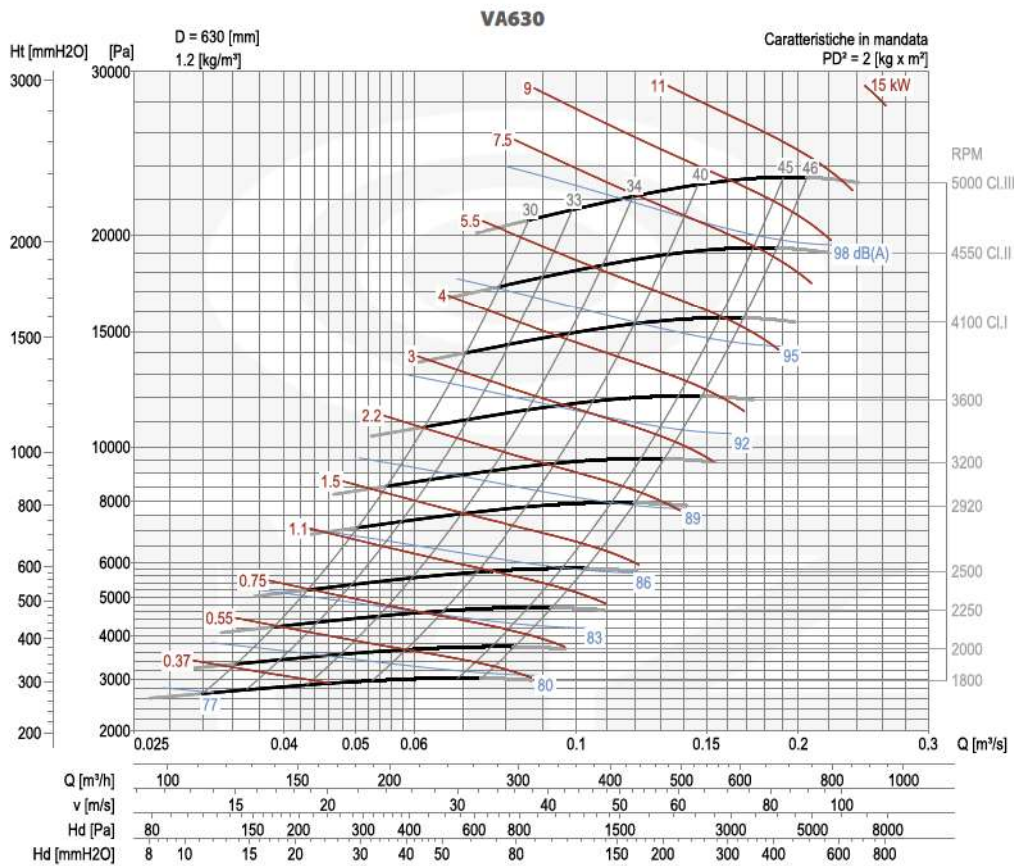

VA

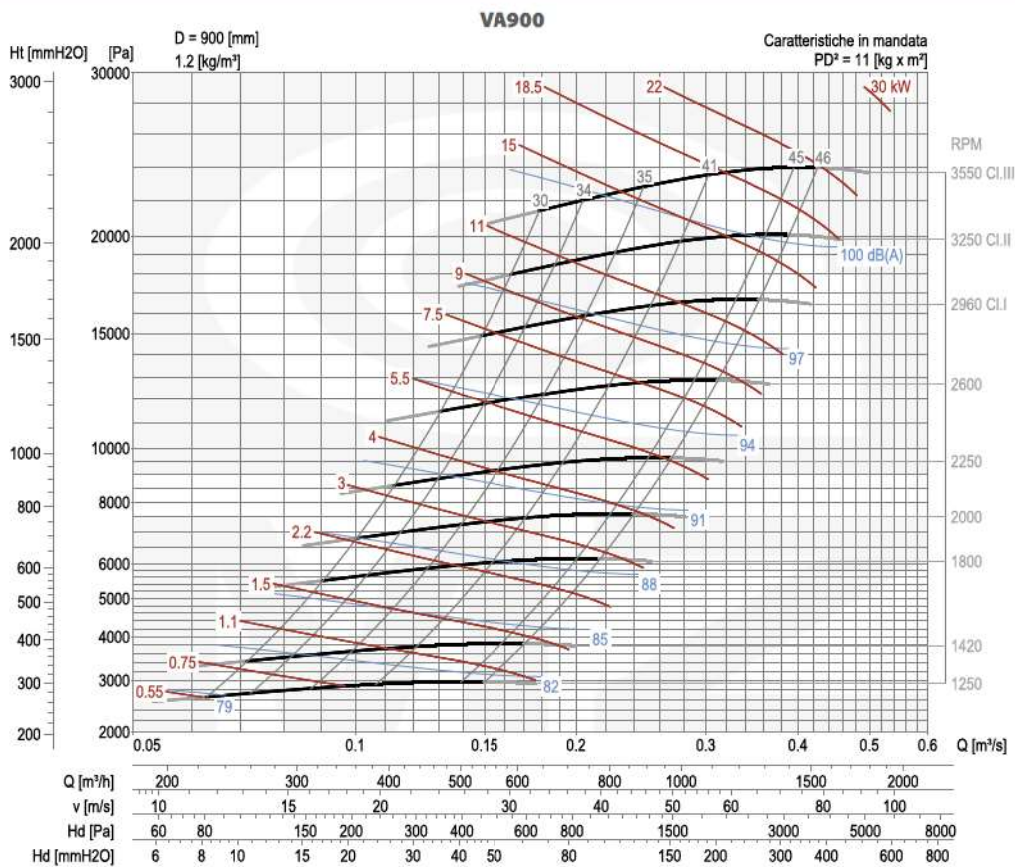
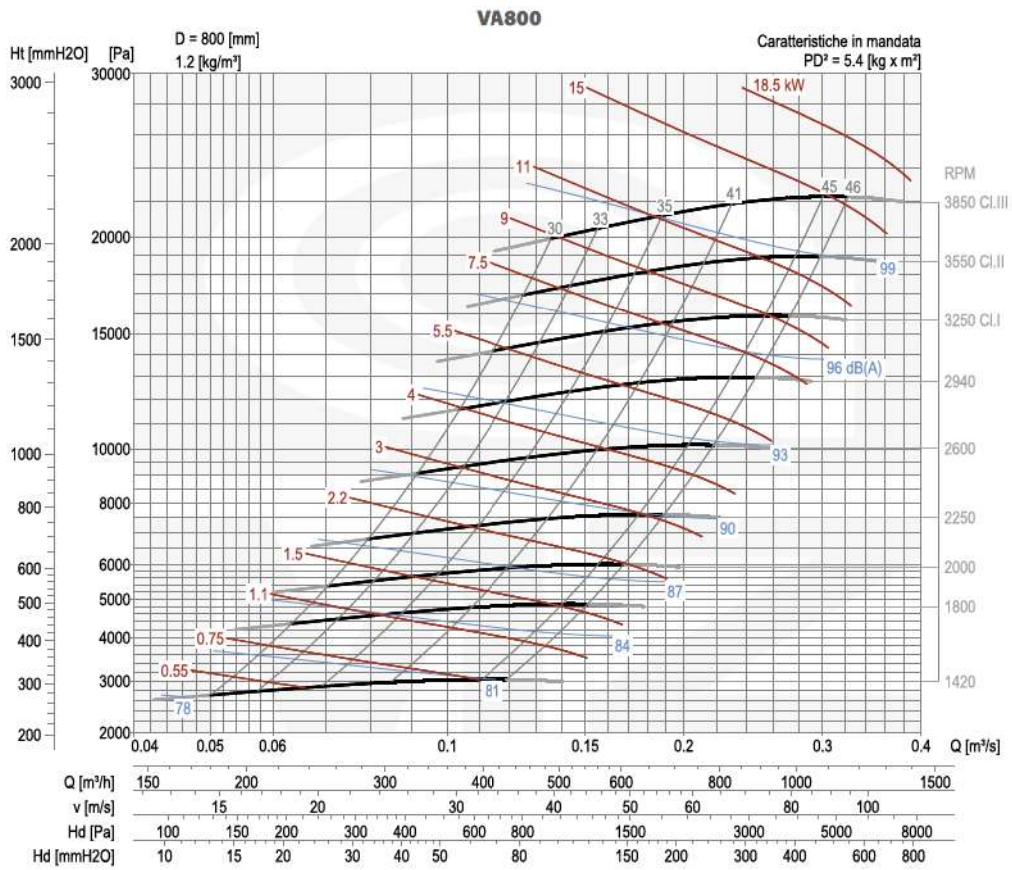

CURVE DI FUNZIONAMENTO

■ COURBES DE FONCTIONNEMENT ■ WORKING CURVES ■ FUNKTIONSKURVEN ■ CURVAS DE FUNCIONAMIENTO

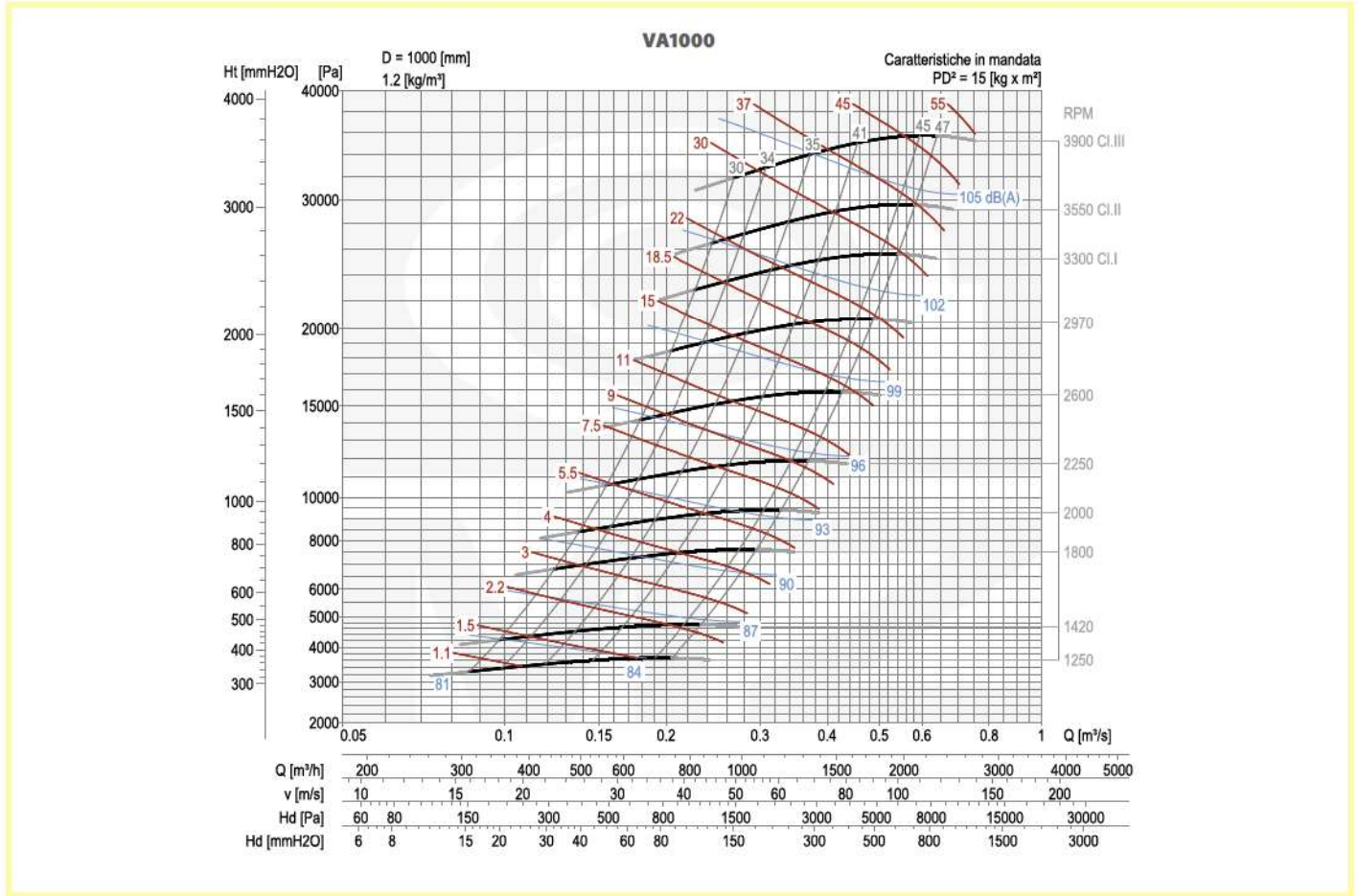

VA